

Pince robuste

706



Description produit

- matière : acier au carbone Premium Flex
- entièrement forgé et trempé
- poignée en bois, laquée







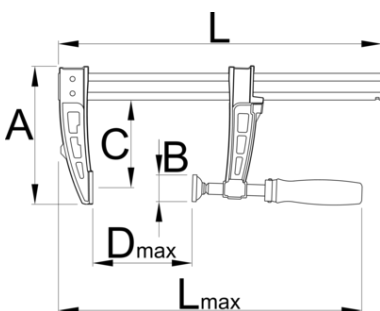

Avantages :

- le frein intégré permet d'éviter les déplacements incontrôlés
- force de serrage 6000N maximum
- profil coulissant dentelé
- coupelle pivotante

Utilisation:

- pour les charpente, la soudure et le montage



								
626283	200	200	323	465	181	136	34	1750
626284	300	300	423	565	181	136	34	1870
626285	400	400	523	665	181	136	34	2090
626286	500	500	623	765	181	136	34	2310
626287	600	600	723	865	181	136	34	2530
626288	1000	1000	1123	1265	181	136	34	3410

* Les images des produits ne sont pas contractuelles. Toutes les dimensions sont en mm, les poids en grammes.

Utilisation (pictures)



Sliding jaw with multiple positioning choices.

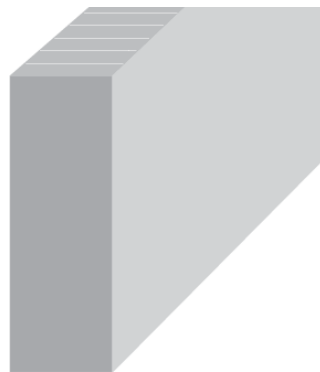

High resistance rectangular steel profiled rail, calibrated and serrated. Surface finish: jaws lacquered, rail zinc plated.



Screw with trapezoidal thread: "Less efforts - more clamping force".



Swivel foot



