

Metal box

981K3/8



Profiles



Product features

- empty tool box designed for storing and carrying of tools
- material: premium PLUS sheet metal
- coated with eco colour of Qualicoat quality standard
- closing mechanism with integrated handle
- box delivered without tool tray and tools

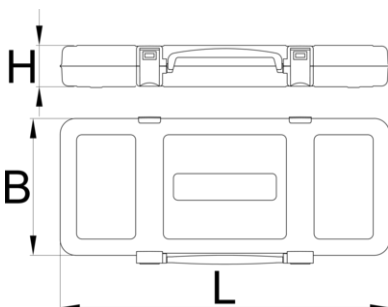



Nº

L

B

H



601913

3/8"

321

198

54

798

* Images of products are symbolic. All dimensions are in mm, and weight is in grams. All listed dimensions may vary in tolerance.