

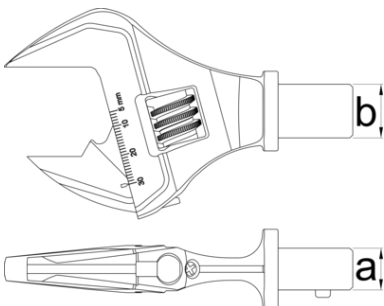





Herramienta de inserción de llave ajustable para 266

266INS.2



Perfiles



					
628103	9x12 (135Nm)	6,8 - 135	9 x 12	30	265
628104	14x18 (200Nm)	10 - 200	14 x 18	30	302

* Las imágenes de los productos son simbólicas. Todas las dimensiones son en mm, peso en gramos.

