

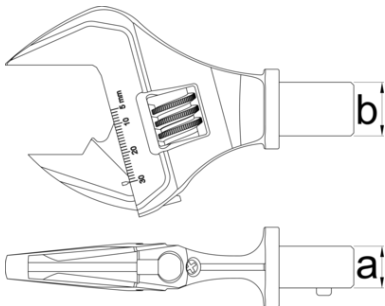





# Adjustable wrench insert tool for 266

266INS.2



## Profiles



					
628103	9x12 (135Nm)	6,8 - 135	9 x 12	30	265
628104	14x18 (200Nm)	10 - 200	14 x 18	30	302

\* Images of products are symbolic. All dimensions are in mm, and weight in grams. All listed dimensions may vary in tolerance.