

加固气动扳手

1563



配置文件



产品属性

- 每分钟8000转的空载转速
- 最大扭矩值745 Nm
- 推荐气压:6.2Bar

- 空气消耗量164升/分钟
- 1/4"进气口
- 噪音水平104分贝(A)
- max bolt size M20

优势：

- 复合外壳
- 排气管处理(静音)
- 单手操作 前进/后退
- 紧凑和强大的
- 机械大锤





用途：

- 汽车行业
- 航空业
- 农业设备
- 重工业
- 大型建筑机械
- 造船业
- 单独安装

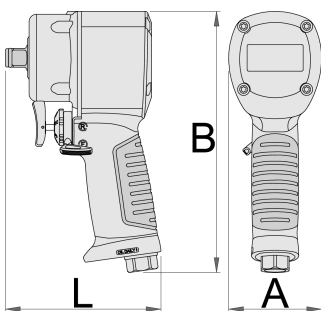
重要事项！

- 务必使用Unior气动套筒



		L	A	B		
627568	1/2"	105,4	63	177	745	1329

* Images of products are symbolic. All dimensions are in mm, and weight in grams. All listed dimensions may vary in tolerance.

用途 (pictures)



Photo (pictures)



Accessories



气动管接头



气动管接头

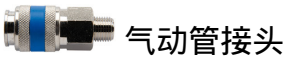

气动管接头

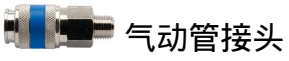

气动管接头



3/8"气动过滤调节器和润滑器



1/2"气动过滤调节器和润滑器



螺旋气动软管

Safety tips



- The pressure in the tool during the operation has to be at least 6.2 bar for the tool to work properly.
- Regularly clean and dry the air filters and inlet air supply.
- Always use clean and dry air with the correct mixture of oil, for maximum tool life.
- Check the joints and ensure that the tubes and other equipment are not damaged before use.
- All tools should be gently oiled prior to being stored.
- Always store pneumatic tools in dry places away from water.
- Always use original spare parts.
- Repairs can be performed only by authorised staff people authorised by Unior d.d.
- Always disconnect tools not in use from the air supply.