

# Ganascia con dado di regolazione per art. 1693

1693.1S-US



## Profili







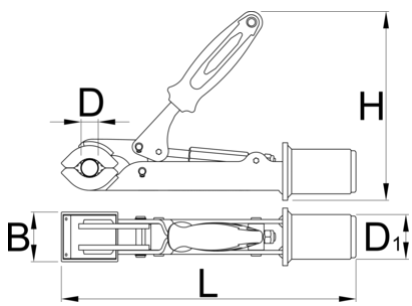

---



## Attributi del prodotto

- Compatibile con tubi con diametro min. Ø24 mm e max. Ø40 mm.
- La vite, facilmente accessibile, consente di regolare l'apertura e la pressione della ganascia. Può essere avvitata manualmente, senza uso di chiavi aggiuntive.



							
629232	24	40	50	45	185	298	1520

\* Le immagini dei prodotti sono puramente simboliche. Tutte le dimensioni sono in mm, peso in grammi.

## Parti di ricambio



Coperture di gomma sostituibili per ganascia, arrotondate, set 2 pezzi