

Mordaza ajustable manualmente para 1693A y 1693B

1693.1S-US









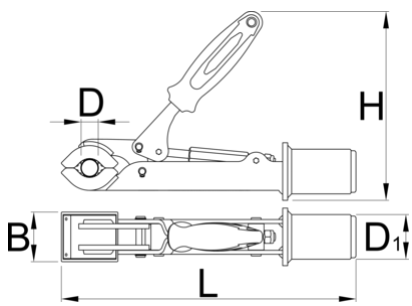

Perfiles



Características del producto

- Apropriado para tubos con diámetro mínimo Ø24 mm y máximo Ø40 mm.
- El fácil acceso del tornillo nos permite que modifiquemos la apertura de la mordaza y la presión cuando se cierra. El tornillo debe ser girado manualmente si ayuda de ninguna llave.



							
629232	24	40	50	45	185	298	1520

* Las imágenes de los productos son simbólicas. Todas las dimensiones son en mm, peso en gramos.

Piezas de repuesto



Cubiertas de goma reemplazables para la abrazadera, redondas, juego de 2 piezas.