

Podesive obrtne stezne čeljusti za art. 1693A i 1693B

1693.1S-US









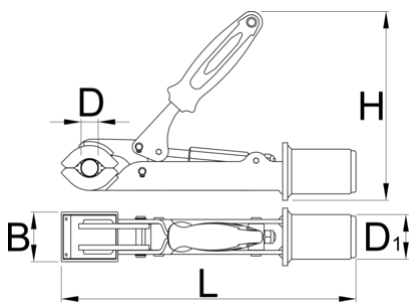

Profili



Atributi proizvoda

- Pogodno za cijevi promjera od min Ø24 mm do max. Ø40 mm.
- Lako dostupan vijak omogućuje da podesimo otvor i stezanje čeljusti. Vijak se podešava jednostavno - ručno, bez dodatnih ključeva.



							
629232	24	40	50	45	185	298	1520

* Slike proizvoda su simbolične. Sve dimenzije su u mm, masa je u g.

Rezervni dijelovi



Replaceable rubber covers for clamp, round, 2 pcs set