

Pro-reparatieklem, handmatig verstelbaar

1693.1S-US









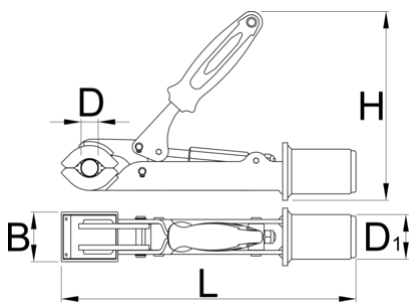

Profielen



Product attributen

- Suitable for tubes with diameter of min. Ø24 mm and max. Ø40 mm.
- Easy accessible screw enables us, to modify the jaw opening and pressure when closed. The screw can be turned by hand without use of any wrench.



							
629232	24	40	50	45	185	298	1520

* Afbeeldingen van producten zijn symbolisch. Alle afmetingen zijn in mm, en het gewicht in grammen. Alle vermelde afmetingen kunnen variëren in tolerantie.

Onderdelen



Vervangbare rubberen bekleding voor klem, rond, set van 2 stuks