

Pro repair clamp, auto adjustable

1693.1-US



Profiles



Product features

- Suitable for tubes with diameter of min. $\text{Ø}24$ mm and max. $\text{Ø}32$ mm.

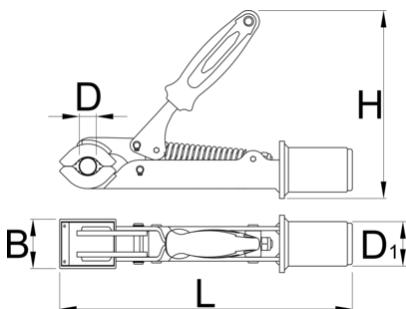

D↓

D↑

B

H

L

D1





D↓

D↑

B

H

L

D1



629233

24

32

50

185

298

45

1562

* Images of products are symbolic. All dimensions are in mm, and weight is in grams. All listed dimensions may vary in tolerance.

Spare parts



Replaceable rubber covers for clamp, round, 2 pcs set



Auto-adjust upgrade set for 1693.1S jaw

Related products



Pro repair clamp, manually adjustable



Pro Shop Clamp



Adjustable screw for clamp 1693.1 and 1693.1S



Auto-adjust upgrade set for 1693.1S jaw



Adjustable screw for clamp 1693.1 and 1693.1S



Auto-adjust upgrade set for 1693.1S jaw