

Hlavica IMPACT 1"

233/4 6p



Profiles



[\(/sk/about-us/materials\)](https://sk/about-us/materials)



[\(/sk/support/warranty\)](https://sk/support/warranty)



Product features

- materiál: premium flex chróm vanádiová oceľ
- kované, tvrdené a temperované,
- čiernený podľa normy ISO 9717
- podľa ISO 2725-2

Standards

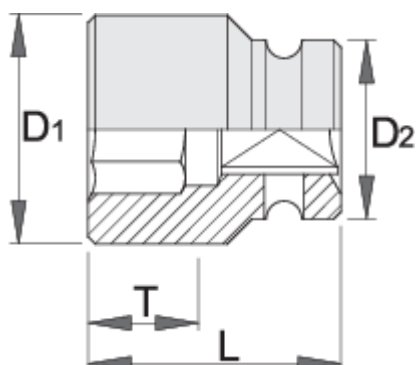

DIN 3129, ISO 2725 - 2





		D1	D2	L	T	
615195	22	40	54	60	15	677
615196	24	42	54	60	18	679
615197	27	46	54	60	19	694
615198	30	50	54	62	21	726
615199	32	52	54	62	22	704
615200	33	53	54	62	22	703
615201	34	55	54	62	22	688
615202	36	57	54	67	25	785
615203	38	60	54	67	25	844
615204	41	63	54	70	27	933
615205	42	65	54	74	27	1055
615206	46	70	54	76	30	1174
615207	50	75	54	80	35	1367
615208	55	81	54	84	35	1632
615209	60	87	54	87	42	1715
615210	65	93	54	90	42	1962
615211	70	100	54	96	42	2370
615212	75	106	86	98	45	3364
615213	80	112	86	100	48	3656





Retail packaging

	MA	MB	MC	
615195	54	54	60	682
615196	54	54	60	684
615197	54	54	60	699
615198	54	54	62	731
615199	54	54	62	709
615200	54	54	62	708
615201	55	55	62	693

	MA	MB	MC	
615202	56	56	67	790
615203	60	60	67	849
615204	63	63	70	938
615205	64	64	74	1060
615206	69	69	74	1179
615207	74	74	80	1372
615208	80	80	84	1637
615209	86	86	87	1720
615210	92	92	90	1967
615211	99	99	96	2375
615212	104	104	98	3369
615213	109	109	100	3661

Transport packaging

		TA	TB	TC	
615195	1				
615196	1				
615197	1				
615198	1				
615199	1				
615200	1				
615201	1				
615202	1				
615203	1				
615204	1				
615205	1				
615206	1				
615207	1				
615208	1				
615209	1				
615210	1				



TA

TB

TC



615211

1

615212

1

615213

1