

Kruissleutel

213/6



Profielen









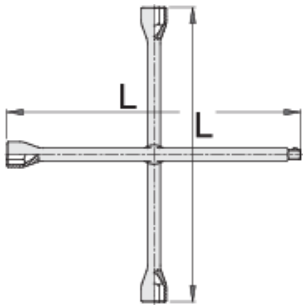

Standaard

ISO 6788

Product attributen

- materiaal: premium chroom vanadium staal
- drop forged, entirely hardened and tempered
- lacquered
- made according to standard ISO 6788 (only metric dimension)



|  |  |  |  |  |  |  |
|--|---|---|---|--|---|---|
| 600811 | 17 | 19 | 22 | 1/2" | 370 | 1430 |
| 600809 | 17 | 19 | 21 | 23 | 370 | 1511 |
| 600812 | 17 | 19 | 22 | 24 | 370 | 1500 |
| 600813 | 24 | 27 | 30 | 3/4" | 700 | 4400 |
| 600814 | 24 | 27 | 30 | 32 | 700 | 4600 |

* Afbeeldingen van producten zijn symbolisch. Alle afmetingen zijn in mm en gewicht in gram. Alle vermelde afmetingen kunnen variëren in tolerantie.

Gebruik (Afbeeldingen)



Foto (Afbeeldingen)

