

Llave de cruz

213/6

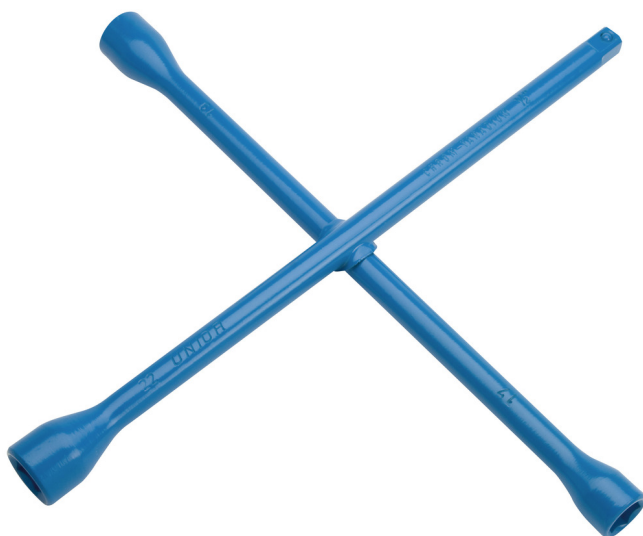

Perfiles









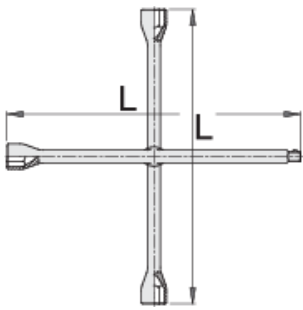

Normas

ISO 6788

Características del producto

- Material: cromo vanadio
- forjada, templada y revenida
- Pintado en epoxi
- fabricada totalmente de acuerdo con ISO 6788 (medidas métricas)



						
600811	17	19	22	1/2"	370	1430
600809	17	19	21	23	370	1511
600812	17	19	22	24	370	1500
600813	24	27	30	3/4"	700	4400
600814	24	27	30	32	700	4600

* Las imágenes de los productos son simbólicas. Todas las dimensiones son en mm, peso en gramos.

Empleo (imágenes)



Foto (imágenes)

