

Four-way rim wrench

213/6

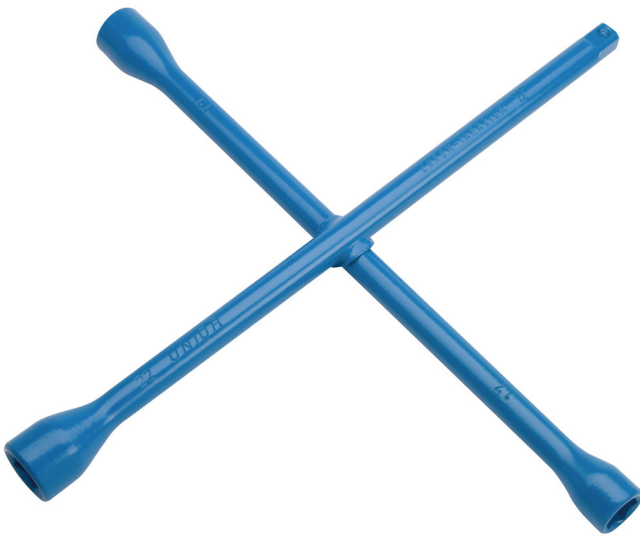

Profiles









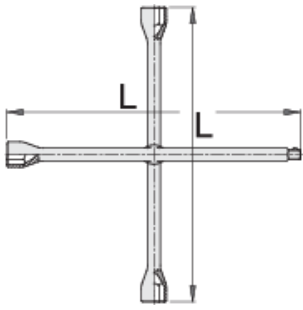

Standards

ISO 6788

Product features

- material: premium chrome vanadium steel
- drop forged, entirely hardened and tempered
- lacquered
- made according to standard ISO 6788 (only metric dimension)



						
600811	17	19	22	1/2"	370	1430
600809	17	19	21	23	370	1511
600812	17	19	22	24	370	1500
600813	24	27	30	3/4"	700	4400
600814	24	27	30	32	700	4600

* Images of products are symbolic. All dimensions are in mm, and weight is in grams. All listed dimensions may vary in tolerance.

Usage (pictures)



Photo (pictures)

