

# 四向车轮扳手

213/6

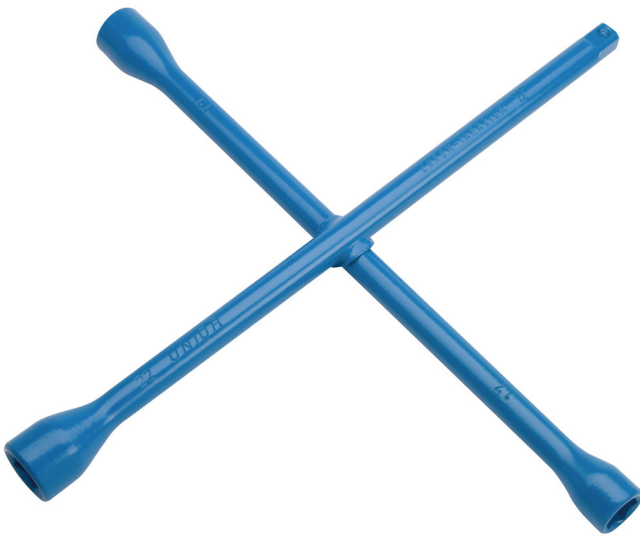

## 配置文件

---



## 标准





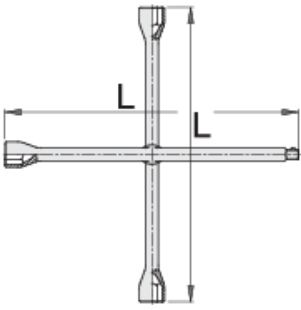

---

ISO 6788

## 产品属性

- 材料：铬钒钢
- 落锻，完全淬火与回火
- 涂漆
- 根据标准ISO6788生产（只限公制规格）



						
600811	17	19	22	1/2"	370	1430
600809	17	19	21	23	370	1511
600812	17	19	22	24	370	1500
600813	24	27	30	3/4"	700	4400
600814	24	27	30	32	700	4600

\* Images of products are symbolic. All dimensions are in mm, and weight is in grams. All listed dimensions may vary in tolerance.

### 用途 (pictures)



### Photo (pictures)

