

Ключ кръстат

213/6

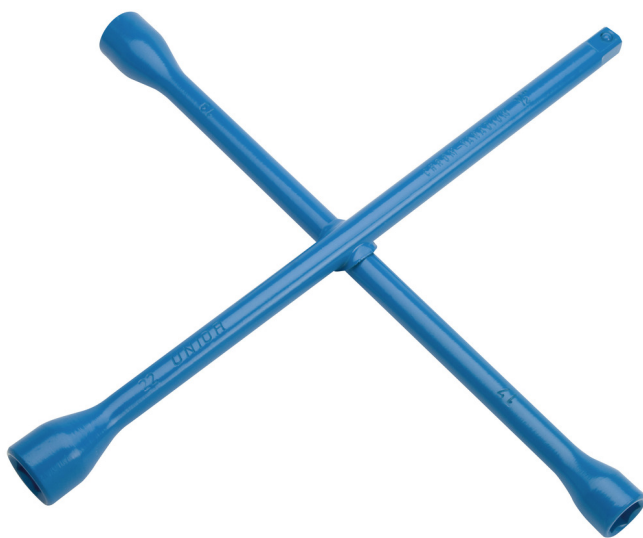

Профили









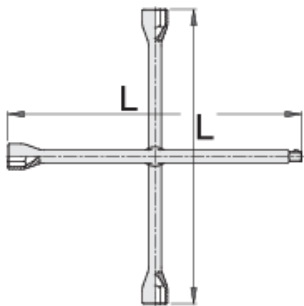

Стандарти

ISO 6788

Параметри на продукта

- материал: хром-ванадий
- ковани, изцяло закалени
- лакиран
- изработен в съответствие със стандарт ISO 6788 (само за метрични размери)



						
600811	17	19	22	1/2"	370	1430
600809	17	19	21	23	370	1511
600812	17	19	22	24	370	1500
600813	24	27	30	3/4"	700	4400
600814	24	27	30	32	700	4600

* Снимките на продуктите са символични. Всички размери са в мм., теглото е в грамове .

Употреба (снимки)



Снимки (снимки)

