

Kreuzschlüssel für Radmutter, sechskant

213/6



Profile



Standards

ISO 6788

Produkteigenschaften

- Material: Premium Chrom-Vanadium-Stahl
- geschmiedet, gehärtet und vergütet
- lackiert
- gefertigt laut Standard ISO 6788 (nur metrische Dim.)

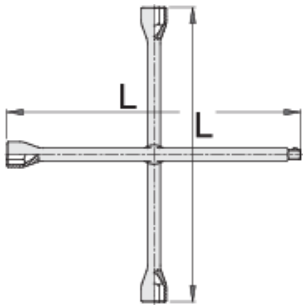

600811	17	19	22	1/2"	370	1430
600809	17	19	21	23	370	1511
600812	17	19	22	24	370	1500
600813	24	27	30	3/4"	700	4400
600814	24	27	30	32	700	4600

* Bilder von Produkten sind Symbolfotos. Abmessungen sind in mm, Gewichte in Gramm.

Verwendung (Bilder)



Foto (Bilder)

