

Coupling, male part

1507Z10

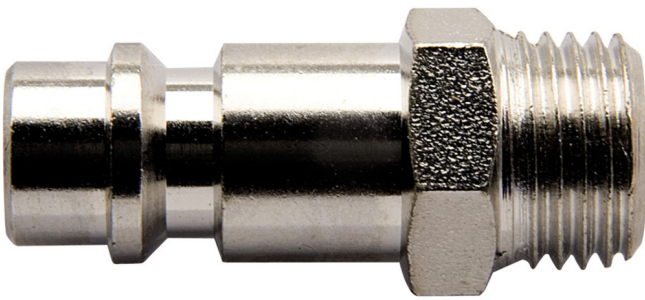

Profiles



Product features

- outside thread
- inside hose diameter Ø10mm
- metal housing



Barcode	mm	mm	L	mm
621455	3/8"	17	39.4	38
621456	1/2"	24	39.4	53



621457

3/4"

27

48.5

86

* Images of products are symbolic. All dimensions are in mm, and weight in grams. All listed dimensions may vary in tolerance.