

# Насаден клуч зглобен 1/4", дванаестоаголен

188/2F12p

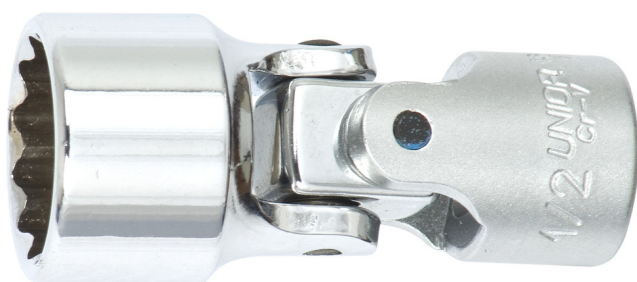

## Profiles



[./mk/about-](#)

[us/materials\).](#)







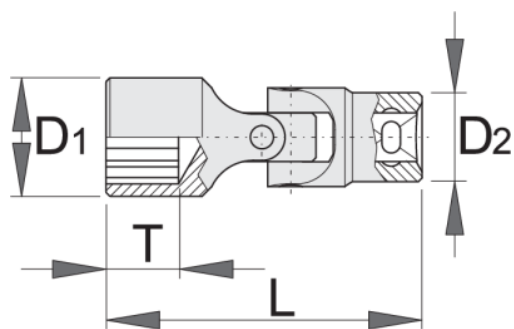

[./mk/support/warranty\).](#)

## Product features

- материјал: специјален флекс хром ванадиум челик
- кован, целосно појачан
- завршна површина: хромирана според ISO 1456:2009



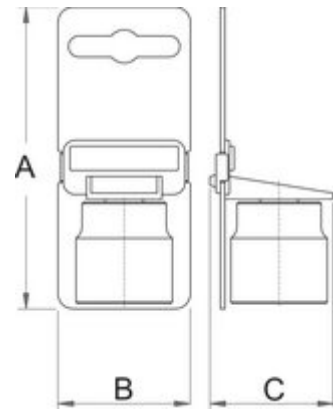

		L	D1	D2	T	
620798	3/16"	35.4	7.7	13.8	4	26
620799	7/32"	35.4	8.6	13.8	4	26

		L	D1	D2	↑	
620800	1/4"	35.4	9.5	13.8	4	26
620801	9/32"	37.4	10.7	13.8	5	29
620802	5/16"	37.4	12.2	13.8	5	29
620803	11/32"	37.4	13.1	13.8	5	29
620804	3/8"	39.9	14.7	13.8	5	29
620805	7/16"	39.9	15.9	13.8	6	29
620806	1/2"	39.9	17.9	13.8	7	29



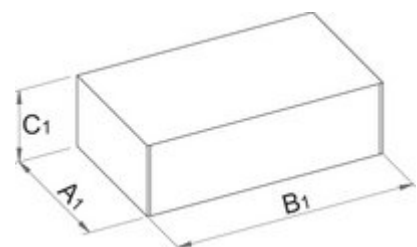

### Retail packaging

	MA	MB	MC	
620798	100	44	23	31
620799	100	44	23	31
620800	100	44	23	31
620801	105	44	23	34
620802	105	44	23	34
620803	105	44	23	34
620804	105	44	23	34
620805	105	44	23	34
620806	105	44	23	34



### Transport packaging

		TA	TB	TC	
620798	4	95	128	34	249

		TA	TB	TC	
620799	4	95	128	34	249
620800	4	95	128	34	249
620801	4	95	128	34	261
620802	4	95	128	34	261
620803	4	95	128	34	261
620804	4	95	128	34	261
620805	4	95	128	34	261
620806	4	95	128	34	261