

Mohutná priemyselná svorka

705/2MH

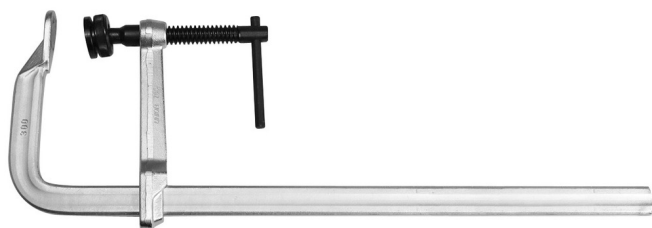

Profiles





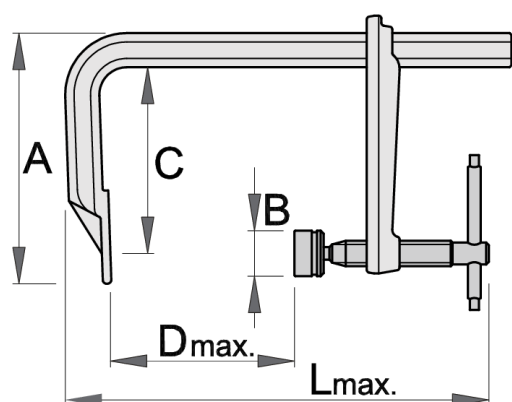

[./sk/support/warranty](https://sk.support.warranty)

Product features



- klzné čeluste sú kované, tvrdené, kalené a galvanicky pokovované
- pätko je vymeniteľná a je otočná, takže môže uchytiť aj materiál s nepravidelnými tvarmi. Vreteno má valcový závit na ľahký posuv a maximálnu upínaciu silu
- pätko, vreteno a rukoväť sú chránené proti korózii





	D \uparrow	C	L \uparrow	A	L	B	
609974	160	140	370	155	280	40	1940
609968	200	140	410	155	315	40	2040

	D↑	C	L↑	A	L	B	
609982	250	140	460	155	370	40	2185
609969	300	140	550	180	415	40	2295
609970	400	140	650	180	520	40	2545
609971	500	140	750	180	620	40	2810
609975	600	140	850	180	720	40	3030
609984	1000	140	1250	180	1120	40	4100

Retail packaging

	MA	MB	MC	
609974	200	280	30	1940
609968	200	315	30	2040
609982	200	370	30	2185
609969	200	415	48	2295
609970	200	520	40	2545
609971	200	620	40	2810
609975	200	720	40	3030
609984	200	1120	40	4100

Transport packaging

		TA	TB	TC	
609974	2	235	420	45	4000
609968	2	235	420	45	4200
609982	2	235	420	45	4490
609969	2	238	410	48	4710
609970	2	235	615	44	5210
609971	2	230	715	41	5740
609975	2	235	910	42	6180
609984	2	235	1180	42	8320