

Štípacie kliešte, tesárske

530/4P



Profiles





Standards

DIN ISO 9243 typ A

Product features

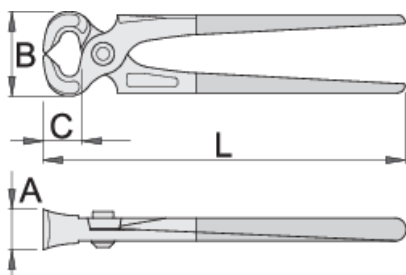
- materiál: premium plus uhlíková ocel'
- tvrdené a kalené
- rezné hrany indukčne tvrdené
- leštené
- povrchová úprava: fosfátované podľa ISO 9717
- tenká plastová rukoväť
- vyrobené podľa ISO 9243



	L	B	A	C	
608723	180	50	23	21	327
608724	200	54	25	24	427
608725	225	54	25	24	428
608726	250	58	26	27	557

* Obrázky sú symbolické. Všetky rozmery sú v mm, hmotnosť je v g. Všetky udané rozmery sa môžu líšiť v rámci tolerancie.

Usage (pictures)

